

1. CALIFORNIA PROPOSITION 65

 **WARNING**

CALIFORNIA PROPOSITION 65

Breathing diesel engine exhaust exposes you to chemicals known to the State of California to cause cancer and birth defects or other reproductive harm.

- Always start and operate the engine in a well-ventilated area.
- If in an enclosed area, vent the exhaust to the outside.
- Do not modify or tamper with the exhaust system.
- Do not idle the engine except as necessary.

For more information go to www.P65warnings.ca.gov/diesel.

2. SAFETY INSTRUCTIONS

Safety Message

Intended Use

Machines should be operated in accordance with the procedures described in the operator manual.

The products described in the operator manual are designed and manufactured mainly for the following purposes:

- Excavation work
- Loading work
- Leveling work
- Drainage work
- Lifting work
- Demolition work

Do not operate the machine for any purpose other than those stated above or in areas where potential hazards have been identified. Make sure that you comply strictly with all safety instructions at all times. Please contact HD Hyundai Construction Equipment Co., Ltd. or your local dealer for more information.

HD Hyundai Construction Equipment strictly prohibits the use or operation of the machine in any of the following circumstances:

- Operation by an unskilled worker
- Lifting a worker up
- Transporting flammable or dangerous materials
- Driving down or extracting piles with the bucket
- Towing damaged vehicles

Safety guidelines

Most safety accidents related to the operation, maintenance/ inspection, and repair of the machine result from a failure to comply with the safety instructions or to take adequate preventive measures. Safety accidents can be prevented by eliminating potentially hazardous situations. The operator should attend all mandatory training courses on the operation of the machine, and fully understand how to use the tools.

Improper operation, refueling, inspection or repair of this machine may cause serious injury or death.

Do not attempt to operate, refuel, inspect or repair this machine before reading and understanding the product information on such tasks.

This manual describes preventive measures and warnings about the product.

Failure to comply with the warnings about potential risks may result in serious injury or death.

General Safety Information

Unauthorized modification

Any attempt to modify the machine, including the use of unauthorized accessories or spare parts, may have adverse effects on the conditions of the machine and its ability to function as it was designed.

Do not attempt to modify the machine in any way without advanced written consent of the company.

Unauthorized modification will void the manufacturer's warranty.

Never modify the operator's cabin by welding, grinding, drilling holes or adding attachments unless instructed by HD Hyundai Construction Equipment in writing. Changes to the cabin can cause loss of operator protection from roll-over and falling objects, and result in serious injury or death.

The user is responsible for all damages and liabilities resulting from unauthorized modifications.

The attachment, the accessory, or the spare part has been made or distributed by HD Hyundai Construction Equipment and has been installed according to approved methods described in a publication available from HD Hyundai Construction Equipment.

Any modification must be approved by the company in writing.

ROPS/FOPS

The cabin is designed to provide sufficient space to minimize impacts pursuant to ISO 12117-2 of Rollover Protective Structures (ROPS). If any additional devices are installed that exceed the Max. certified weight indicated on ROPS name plate, the ROPS certification may be nullified. The protective structure of the cabin should be replaced immediately if it is permanently deformed or damaged.

Machines operated in areas where there is a risk of objects falling onto the cabin are fitted with a Falling Object Protective Structure (FOPS) pursuant to ISO 10262.

Fire and Explosion

Preventing fires

The following actions should be taken to minimize the risk of fire:

- Do a visual inspection before operating the machine to check for any risk of fire.
- Do not operate the machine if there is a risk of fire.
- Be sure to identify the primary exit and alternative exit of the machine, and fully understand how to use the exits in the event of a fire.
- Do not perform any welding or drilling work on the engine cover.
- Keep the engine compartment free from the build-up of flammable materials such as dead leaves, small branches, paper, and other types of trash.
- Keep the covers of the major parts of the machine closed. Make sure that the covers operate normally in order to be able to use firefighting equipment in the event of a fire.
- Be careful when handling fuel. Fuel is a highly flammable.
- Always stop the engine when refueling the machine.
- Refuel outdoors.
- Remove any build-up of flammable materials from the machine.
- Do not operate the machine near a flame.
- All fuels and most lubricant and coolant mixtures are flammable materials, so special care should be exercised when handling such materials to prevent fire and explosion.
- Keep all fuels and lubricant in adequate containers.
- Never smoke in the area where refueling is taking place or in the space for handling battery electrolytes and other flammable materials.
- Oil leaked to a hot surface or electronic component may cause a fire.
- Do not operate the machine if there is an oil leak. Repair the source of the oil leak, and wipe clean any leaked oil before operating the machine.
- Always clean all electrical lines, connectors, and clamps, and check whether they are securely connected on a regular basis.
- If any electrical wire or connector is loose or damaged, repair it immediately.
- Do not weld, cut or use a cutting torch through any tubes or lines in which flammable flows. Check all tubes and lines for signs of abrasion or deterioration and replace if damaged.
- Dust or particles generated when repairing the non-metallic hood or fender are flammable or explosive. Repair such parts in a well ventilated area well away from flames or sparks, and be sure to wear suitable PPE (Personal Protective Equipment).



Preventing explosions

The following actions should be taken to minimize the risk of explosion:

- Never use starting aid fluid in a low-temperature environment as it can have an adverse effect on the engine performance and may cause an explosion.
- Do not attempt to charge a frozen battery. Forcibly charging a frozen battery may result in an explosion.
- Use caution when handling the batteries. Never let a tool make contact with the positive battery post and the frame of the machine simultaneously. Sparks may be generated, resulting in an explosion.
- Only charge the battery with a charger of equal voltage. Incorrect voltage may cause overheating and explosion.
- Do not use or charge the battery if the level of electrolytes in the battery is low. Regularly check the electrolyte level, and refill with distilled water to the maximum level.
- Do not attempt to start the engine using an unsuitable booster cable as it may result in an explosion and serious injury or death. Only use the booster cable to start the engine in a well ventilated open space. Starting the engine with a booster cable may generate flammable gas.
- When hydraulic equipment and piping are overheated, flammable gas or airborne particles may explode. Protect and insulate such parts to prevent overheating.

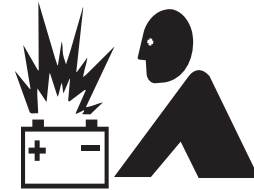

Corrective Actions Before and After a Fire

In the event of a fire in the machine, the top priority should be the safety of the operator and workers in the work area.

In the event of a fire at a level that does not endanger the operator or workers, the following actions should be taken:

- Move the machine well away from any flammable materials (e.g., fuel, engine oil, clothes, and bits of wood) and adjacent buildings.
- If the engine is running, it may cause a persistent fire. Immediately stop the engine.
- In the event of an electric short, disconnect the batteries to eliminate the main ignition source.

In the event of an electricity leak resulting from damage to the power wiring caused by fire, disconnect the batteries to eliminate the secondary ignition source.

If a fire becomes too large to control, assess the following risks:

- The tank, accumulator, hose and fitting may burst into flames, splashing fuel and scattering particles throughout the surrounding area.

If you have to handle a machine that has been damaged by fire or one that is exposed to excessively high heat after extinguishing a fire, take the following precautions:

- Wear thick protective gloves and protective goggles.
- Never touch any materials left after combustion with your bare hands.
- Avoid contact with melted polymer materials (e.g., plastics).

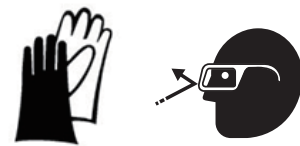

Information on fire extinguisher

Fire extinguishers (if equipped) should be kept in a fully operable condition, and be inspected by a qualified person on a regular basis. Workers should complete a training course on the use of fire extinguishers in advance.

Use fire extinguishers in accordance with the following procedures, if required:

- ① Pull the safety pin of the fire extinguisher first.
- ② Extend the nozzle, and stand toward the fire.
- ③ Aim the nozzle at the flames, and firmly press the top and bottom handles.
- ④ Stand in a downwind position, and evenly spray the foam over the flames.

If the weight of the fire extinguisher exceeds 4.5 kg, mount the extinguisher in a location near the bottom of the cabin. Do not mount the fire extinguisher at a level higher than one third of the height of the cabin.

Do not weld or drill ROPS to mount a fire extinguisher. Contact your dealer or distributor for more information about the correct mounting of fire extinguishers.











Health and Safety

Personal protective equipment

The wearing of personal protective gear is mandatory for protecting the human body from hazardous chemicals and hazardous environments.

The wearing of personal protective gear is a means of preventing injury, and should not interfere with the performance of jobs. It is designed to protect the human body from hazardous environments and hazardous materials, and should be kept in an easily accessible place.

List of personal protection gear

Name	Symbol	Remarks
Safety helmet		Protects the head from falling objects, and reduces risks when falling down.
Dust mask		Air-purifying dust mask should not be worn in workplaces with an oxygen concentration of less than 18%.
Gas mask		Prevents the inhalation of mist, airborne particles, or protects against the spray of hazardous chemicals.
Welding helmet		Blocks airborne dust and slag, and shields the face from bright light during welding.
Protective clothing		Blocks dust, mist and hazardous chemicals, and protects against burns.
Protective gloves		Electric insulation gloves: Should be worn when working in areas with a high risk of electric shock. Chemical protective gloves: Should be worn when working in areas where there is a risk of contact with hazardous chemicals including materials leaked from batteries.
Protective goggles		Protects the eyes from dust, particles and airborne materials in work areas.
Earplugs and earmuffs		Wear earplug and earmuffs separately or in combination depending on the level and duration of noise.
Safety shoes		Protects the feet from falling objects, impacts, and sharp objects.

Health and safety instructions in hazardous environments

Comply with the following instructions during operation and maintenance of the machine.

When handling oil

Failure to wear personal protection may result in burns caused by contact with a high-temperature liquid. Make sure you wear protective goggles, protective gloves and protective clothing when handling oils such as hydraulic oils and engine oil.

If the eyes come into contact with oil, wash them with a sufficient quantity of water for 15 minutes or longer. If the skin comes into contact with oil, take off contaminated clothes and shoes, and wash the skin with soap and water for 15 minutes or longer.



When handling the battery

If battery electrolyte leaks while handling the battery, the sulfuric acid contained in the electrolyte may cause burns. The lead components in battery electrolyte are toxic, so be sure to wear protective gloves and protective clothing. Always wash your hands after handling the battery.

If a part of your body not protected by personal protective equipment comes into direct contact with battery electrolyte, immediately wash the affected part with flowing water for 20 minutes or more, and then see a doctor without delay.

If you accidentally swallow battery electrolyte, drink water, do not forcibly induce vomiting, and immediately seek medical help.

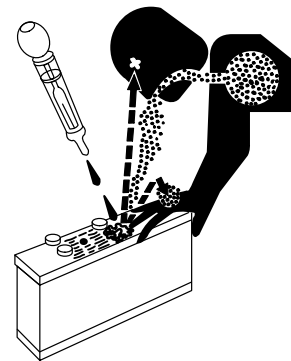

When handling refrigerant

Always wear protective goggles, protective gloves and other personal protective equipment when handling refrigerant to prevent direct contact of the skin with the refrigerant.

Wear protective gloves made of materials that are resistant to chemicals (such as neoprene and butyl rubber).

Never smoke when handling refrigerant.

If refrigerant comes into direct contact with the skin, wash the skin with warm water immediately.



When handling coolants

Do not remove the radiator cap after operation of the machine until the engine has cooled and the pressure has dropped to a safe level. Failure to comply may result in serious burns.

Coolant contains toxic and combustible ethylene glycol, and should be handled in a cool, well-ventilated place only when wearing protective goggles, protective gloves, protective clothing, and a gas mask.

Avoid inhaling airborne particles or spray from coolant. If the substances make contact with skin or eyes, immediately wash the skin and eye with flowing water for 20 minutes or longer.



When working in a place subject to airborne particles and falling objects,

Always wear a safety helmet, protective goggles and safety shoes to prevent injury from airborne particles and thrown or falling objects. Earplugs or earmuffs may be necessary when working in a noisy place.









When working in places with a high level of noise

When the operator is exposed to the noise exceeding 90 dB (A) for 8 hours or longer, wear earplugs or earmuffs.

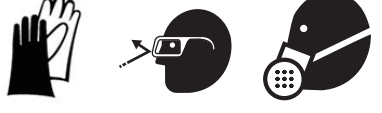

Personal protection gear for various situations

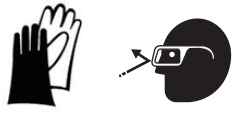
Situation	Symbol
Oil handling	
Battery handling	
Refrigerant handling	
Coolant handling	
Repair by welding	
Working in areas subject to airborne particles and falling objects	
Working in places with a high level of noise	
Handling machines damaged by fire or exposed to excessively high temperature	

WEAR PROTECTIVE CLOTHING

Wear close fitting clothing and safety equipment appropriate to the job.

- Do not wear loose clothing and accessories. Secure long hair. These items can snag on controls or on other parts of equipment.
- Do not wear oily clothes. They are highly flammable.
- Wear a hard hat, safety shoes, safety goggles, mask, leather gloves, earplugs and other protective equipment, as required.
- While working on machine, never use inadequate tools. They could break or slip, or they may not adequately perform intended.

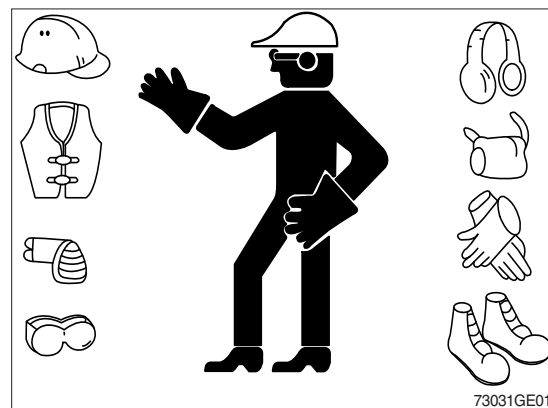

73031GE01

Noise and Vibration

Information on vibration

This part describes the vibration data of the machine, and methods of calculating the vibration level.

The vibration level of the machine varies according to any of the following conditions:

- Driving habits of the operator
- Quality of seat and suspension
- Type of machine, attachments, and conditions of machine
- Conditions of work site, working environment, ground surface conditions, and weather

Vibration also varies according to the duration of operation.

Physical Agents Directive 2002/44/EC defines the exposure action value as 0.5 m/s^2 , and the exposure limit value as 1.15 m/s^2 . If the predicted value is near the exposure action value or exposure limit value, the predicted value should be assumed to exceed the two latter values, and necessary action should be taken.

In regards to the actions taken according to the vibrations, refer to the following table:

Daily vibration exposure (A(8))	Vibration exposure range	Actions to be taken
$A(8) \leq 0.5 \text{ m/s}^2$	Exposure action value or lower	When approaching the exposure activity value, reasonable measures should be taken to minimize exposure to vibration. The relevant information and opportunities for training on vibration reduction should be provided to the operator.
$0.5 \text{ m/s}^2 < A(8) \leq 1.15 \text{ m/s}^2$	Exceeding the exposure action value, but not exceeding the exposure limit value	It is required to execute certain measures for reducing exposure to and risks of vibration to the minimum. The health of an operator who has been exposed to excessive vibration should be examined.
$1.15 \text{ m/s}^2 < A(8)$	Exceeding the exposure limit value:	Immediate action is required to reduce the vibration exposure level to below the exposure limit value.

※ For further information, please contact your local HD Hyundai Construction Equipment dealer.

The vibration level can be predicted based on the information in the following table which is used to calculate the daily level of vibration exposure.

Predict the vibration level in the three vibration directions of axes X, Y, and Z. The mean vibration level should be used under normal operation conditions. Scenario factors from mean vibration level based on operation by skilled operator and on smooth terrain are excluded. Scenario factors are included to obtain the mean vibration level based on aggressive operation and severe terrain to assess the expected vibration level.

※ All vibration values are indicated in m/s^2 .

ISO Reference table - Vibration level equivalent to whole body vibration emission of the excavator (Unit : m/s^2)

Machine family	Machine kind	Typical operating condition	Vibration Levels			Scenario Factors		
			X axis	Y axis	Z axis	X axis	Y axis	Z axis
Excavator	Compact crawler excavator	Excavating	0.33	0.21	0.19	0.19	0.12	0.10
		Hydraulic breaker app.	0.49	0.28	0.36	0.20	0.13	0.17
		Transfer movement	0.45	0.39	0.62	0.17	0.18	0.28
	Crawler excavator	Excavating	0.44	0.27	0.30	0.24	0.16	0.17
		Hydraulic breaker app.	0.53	0.31	0.55	0.30	0.18	0.28
		Mining application	0.65	0.42	0.61	0.21	0.15	0.32
		Transfer movement	0.48	0.32	0.79	0.19	0.20	0.23
	Wheeled excavator	Excavating	0.52	0.35	0.29	0.26	0.22	0.13
		Transfer movement	0.41	0.53	0.61	0.12	0.20	0.19

Instructions on mitigating vibration

Machines should be correctly adjusted and maintained to ensure smooth operation. The terrain conditions should be observed. The following instructions will help reduce the whole body vibration level:

- ① Use the correct size attachments for your machine.
- ② Maintain the machines pursuant to the manufacturer's recommendations.
- ③ Maintain and provide good terrain conditions.
 - Remove any large rocks or obstacles.
 - Fill gutters or holes.
 - Adjust speed and driving path as needed for the conditions.
- ④ Use a driver's seat that satisfies ISO 7096.
 - Adjust the driver's seat and suspension for the weight and the size of the operator.
 - Inspect the suspension and adjusting devices of the driver's seat.
- ⑤ Perform the following maneuvers without using excessive force :
 - Steering
 - Braking
 - Accelerating
 - Gear shifting
- ⑥ Move the attachments smoothly.
- ⑦ Keep the level of vibration minimal when working for a long time or driving for a long distance.
 - Use a machine mounted with suspension system.
 - Transport the machine when moving between worksites; do not drive the machine to get to another worksite.
- ⑨ Take the following actions for optimal operator comfort and convenience:
 - Adjust the driver's seat adjustment device to allow a convenient posture.
 - Adjust the angles of the mirrors to minimize awkward, compromised posture
 - Avoid working for an excessively long time, and take regular breaks.
 - Do not jump on or off the cabin.
 - Minimize repeated handling of loads and lifting of loads.
 - The vibration information and calculation procedures are based on <ISO/TR 25398> has been defined according to the emission of vibrations measured under the actual working conditions of the machines.

Information on noise

Noise level (EN 474-1:2018 and 2000/14/EC) are as follows :

- Sound pressure level (LpA) : See pages 0-3.
- Sound power level (LwA) : See pages 0-3.

Emergency situations

In the event of an emergency situation, use the emergency hammer installed inside the cabin to break the windshield of the cabin, and carefully escape from the cabin. The emergency hammer should always be kept inside the cabin for emergencies, and should not be removed or used for other purposes. If the emergency hammer is lost, replace it immediately.

Keep a first-aid kit inside the cabin or in another place at the worksite for safety accidents.

Keep contact information (e.g., phone number) to request help with an emergency situation or injury.

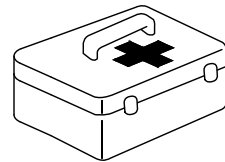
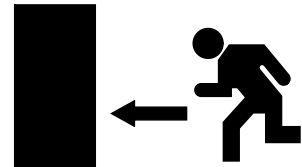

Safety Information on the Machines and Operation

Before Operating the Machine

Carefully examine the following conditions and take any necessary actions to prevent risk factors before operating the machine:

Checking the worksite

- Always be aware of weather conditions at your worksite. Fog or heavy rain may decrease visibility or render the machine inoperable. In the event of lightning, immediately put the bucket to the ground and evacuate to a safe place.
- Check the worksite for obstacles, and avoid collisions with such obstacles during operation. Check the surroundings of the machine for any obstacles that may hinder operation.
- Check the worksite for buried waterlines, telecommunication cables, power cables and oil pipelines in advance, and avoid damaging them.
- If the terrain of the worksite is too rough for normal operation of the machine, flatten the terrain before operating the machine. Make sure that the ground of the worksite is not soft as it may cause hazards during operation.
- If the worksite is a marshy place (e.g., shallow river, large or small lake, swamp, etc), check the conditions and the depth of marshy areas and the flow rate before driving or operating the machine. Do not operate the machine underwater.
- When operating the machine in water or when crossing shallow, check the bed soil condition and depth and flow speed of water, then proceed taking care that water is not above upper rollers.
- Do not operate the machine on cliffs or at the end of a road on soft ground as the machine may overturn. If operation of the machine on such terrain is unavoidable, keep the track perpendicular to the end, place the driving motor at the rear to facilitate escape from the machine in the event of an emergency situation.
- When operating the machine in areas with pedestrian or vehicle traffic, or in a zone in the vicinity of such an area, appoint workers exclusively responsible for controlling the traffic, or install fences or blocking wall to separate the worksite from the traffic area. Prevent unauthorized workers or machines from accessing the worksite.

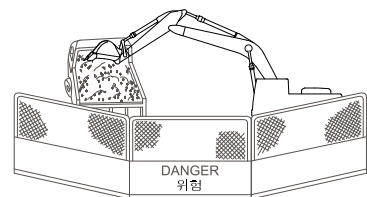
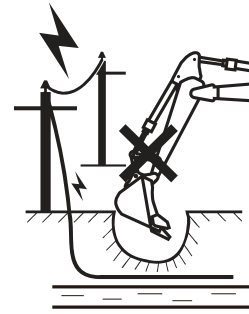

Instructions before operating the machine

- The machine shall be operated by authorized and skilled operators only.
- The operator should wear clothes and personal protection gear that are appropriate for the work environment.
- Do not operate the machine while under the influence of alcohol or drugs or while experiencing extreme fatigue or other conditions that may affect your awareness of your surroundings or your reaction time.
- The operator should read and fully understand the operator's manual before operating the machine.
- The operator should fully understand the details and procedures of the work to be performed.
- Do not perform work when a hazard is anticipated or encountered. Remove the hazard before beginning work. Failure to comply may result in serious injury or death.

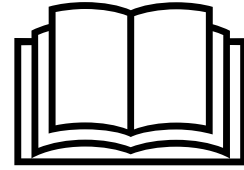

Inspect the machine before operating the machine

- Check the machine for abnormal noise, vibration or heat, and for the leakage of engine oil, hydraulic oil, fuel or refrigerant.
- Remove any foreign substances from the engine and the battery. The buildup of such substances may cause a fire.
- Do not operate a machine until any necessary repairs are completed.
- Do not operate the machine until all regular inspection and service recommended in the operator's manual have been executed.

- Adjust the operator's seat to suit the physical condition of the operator. Check the seatbelt for damage, and replace it if damaged. Do not store unnecessary objects or tools in the cabin.

- Keep clean all parts related to visibility, such as the windshield and rearview mirror. Adjust the rearview mirror to ensure that the operator's field of vision is clear.

- Check the acoustic alarms (e.g., the horn and warning signal when driving backward or moving) for normal operation.

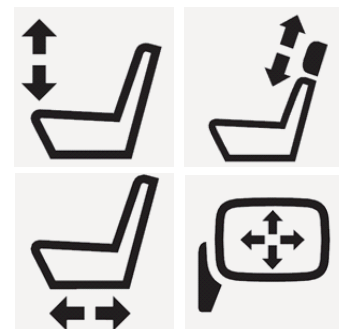

During Operation of the Machine

Getting on and off

- Do not jump on or off the machine.
 - Do not try to get on or off the machine while it is moving.
 - Get on or off the machine using the handrail and step (or stepladder, if any). Always keep the handrail and step clean and free from mud or oil.
 - Wear anti-slip shoes.
 - Comply with the principle of three-point contact* by contacting the machine with either both hands and one foot or vice versa when getting on or off the machine.
 - Do not sit on any part of the machine not intended for sitting.
- ※ **Three-point contact means making contact with the machine with both hands and one foot, or with one hand and both feet.**

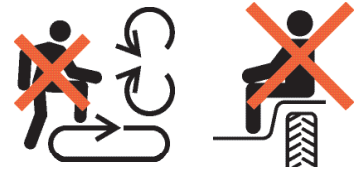

During operation

- The operator should start the engine only after sitting on the operator's seat. Make sure that all levers are shifted to the neutral position before starting the engine.
- Pay close to any obstacles when operating the machine, particularly when turning or moving backward, to prevent collision. Failure to comply may result in serious injury or death.
- Do not exceed the recommended size and weight of an object when lifting a load. Do not lift a heavy object with slings by suspending the slings on the tooth of the bucket.
- Do not allow anyone to stand under the bucket.

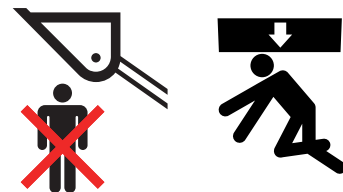
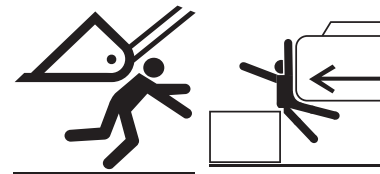

Operation on a slope

When operating the machine on a slope, failure to comply with these instructions could result in the machine tipping over, which may lead to serious injury or death.

- Do not work on slopes of 10° or more.
- Do not exceed the maximum climbing angle of 30°.
- If operation of the machine on a slope is unavoidable, perform the work after flattening the ground.
- When operating the machine laterally on a slope, there is a high risk of machine overturning or slipping. Do not operate the machine in such conditions.
- Do not operate the machine on a slope covered with wet grass or a thick layer of dead leaves, as the machine may slip.
- Do not park or stop the machine on a slope. If parking or stopping the machine on a slope is unavoidable, bring the bucket down to the ground, and support the wheels with wheel chocks.

- When traveling up a slope, operate the machine at a slow speed with the attachment extended forward to keep the machine balanced, and with the bucket raised at least 20 ~30 cm (1 ft) from the ground.
- When traveling down a slope, reduce the engine speed with the travel lever kept in the vicinity of the neutral position. Keep the bucket 20~30 cm (1 ft) above the ground, and use the bucket as a brake in an emergency situation.
- If the engine suddenly stalls, immediately bring the bucket to the ground.
- If the fuel gauge reaches the red zone while operating the machine, immediately refill with fuel. (If the machine operates on a slope under these conditions, air may be introduced into the engine, causing it to stall suddenly.)

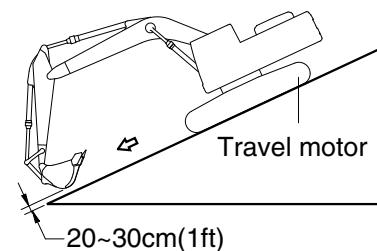
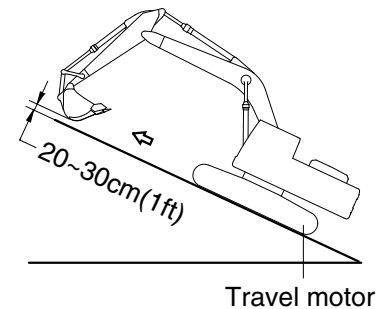
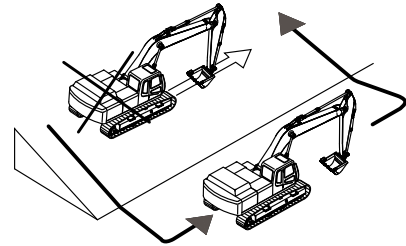
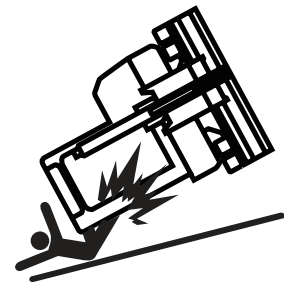

Operations to be avoided or prohibited

- Pay attention when operating the machine in an enclosed space as this may result in the risk of a buildup of hazardous gases.



- If the machine is operated in the vicinity of a high-voltage line, there is a risk of death or serious injury.
- Be aware of the height and working radius of the machine, and maintain the minimum safety distance.

Voltage	Minimum safety distance
6.6 kV	3 m (10 ft)
33.0 kV	4 m (13 ft)
66.0 kV	5 m (16 ft)
154.0 kV	8 m (26 ft)
275.0 kV	10 m (33 ft)

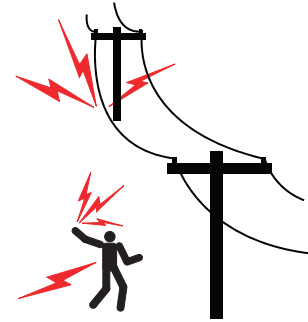

- In the event of contact with a high-voltage line, keep sitting on the operator's seat until the electric current has been shut down.
- Warn any workers on the ground in the vicinity of the machine not to make contact with the machine.
- If leaving the machine is unavoidable, jump down to a place free from any contact with the machine.
- Avoid operating the machine on soft ground, a slope or cliff as there is a risk that it may overturn. Pay special attention when it is raining as the rainfall may soften the ground.
- When operating or driving the machine in water, check the floor conditions, depth of water and flow rate, and make sure that the top roller and axle housing are not immersed in water.
- Do not operate the machine under adverse weather conditions caused by overcast skies, snow and rainfall.
- Do not turn or travel with the machine when the bucket is stuck in the ground.

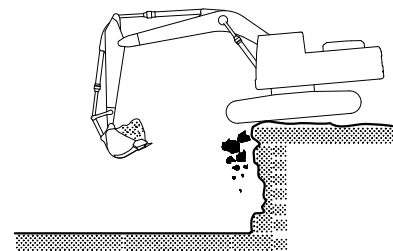
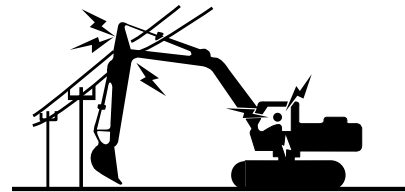

Cautions when operating in specific areas

Operating in extremely cold environments

- Do not attempt to start, stop or turn the machine suddenly as this may cause it to slip. There is potential for the machine to slip.
- Snow-covered or frozen ground may be slippery and dangerous.
- Idle operation of the machine may be required to elevate the engine temperature during startup.
- An impact resulting from a sudden movement of the boom or the attachments at an extremely low temperature may cause serious damage to the machine.
- The working cycle or loading weight might be reduced to lower than those under normal conditions.
- Follow these instructions when operation in cold environments:
 - Warm up the engine for 3~4 seconds when starting up the engine.
 - Always fully charge the battery. A discharged battery will freeze earlier than a fully charged battery.
 - Use engine oil and fuel that are appropriate for the temperature.
 - Keep the fuel tank full.
 - Remove any moisture from the fuel tank, and change the fuel filter regularly.
 - If the fuel filter is frozen, the flow of fuel may be blocked.
 - Pour the proper volume of antifreeze into the coolant.
 - Wait until the various parts of the machine reach the operating temperature after starting the engine.
 - Make sure that every controller and function of the machine operates normally.
 - Remove any dirt, snow and ice from the machine after completing the operation.

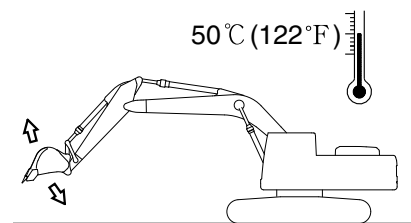

Operating in extremely hot environments

- Continuous operation of the machine for a long period of time may cause the machine to overheat. Pay special attention to prevent overheating of parts such as the engine and the hydraulic system. Stop the machine and take a break if necessary.

Check the following conditions frequently:

- Check the level of the coolant in the radiator.
- Check the radiator grill for clogging by any debris, and remove them, if any.
- Check the level of the battery electrolyte.
- If the battery will not be used for a long period of time, store it in a cool place.
- Check the hydraulic system for oil leakage.
- Check the lubrication oil on the respective parts, and lubricate as needed.
- If the paint coating of any parts has been effaced or damaged, coat the parts with paints or treat them with an anti-rust additive.
- Do not park the machine under direct light for a long period of time.
- When parking or storing the machine outdoors, use the proper cover to protect the machine from sunlight and dust.

Operating in dusty or sandy environments

- Check the radiator grill for clogging by any debris, and remove any debris.
- Check the fuel system, and protect it from dust or sand when refueling.
- Inspect the air cleaner regularly, and replace it if necessary.
- If the gauge lamp on the dashboard lights up and the buzzer sounds at the same time, clean or replace the air cleaner.
- Frequently check consumables such as hydraulic oil and lubrication oil, and change them if necessary. Protect against the introduction of dust or sand when changing the consumables.
- Check the air-conditioner and the heater filters regularly, and clean or replace them if necessary.
- When parking or storing the machine outdoors, use the proper cover to protect the machine from dust and sand.

Operating in rainy or humid environments

- Do not operate the machine in areas where there is heavy rainfall or thick fog.
- If operating the machine in such areas is unavoidable, perform operation after ensuring sufficient field of vision.
 - Use lighting devices such as the head lamp and working light.
 - Warn any workers within the radius of operation of the machine.
- Pay attention when operating the machine on smooth ground as there is a risk of it overturning.
- If the paint coating on any parts has been effaced or damaged, coat the parts with paint or treat them with an anti-rust additive.

Operating the machine in coastal areas

- Special care should be taken when operating the machine in coastal areas as exposed parts may be corroded easily.
- If the paint coating on any parts has been effaced or damaged, coat the parts with paint or treat them with an anti-rust additive.
- Perform inspection and maintenance of the parts promptly.

Cautions during maintenance

Tools

- Use the correct tools for each type of work.
- Using improper tools may damage the machine and its parts.
- Using deteriorated or damaged tools may result in bodily injury.



Inspection and servicing

- Prevent access to the machine by all unauthorized workers.
- Prior to inspection, park the machine in a flat area and attach a 'Under Inspection' sign.
- Clean the machine before inspection or maintenance.
 - When performing inspection or maintenance on a dirty machine, it may be difficult to diagnosis or detect the cause of a problem with the machine.
 - Dust or dirt accumulated on the machine may cause a worker to slip or fall.
 - Wear protective goggles and protective clothes when cleaning the machine using a compressed water.
 - Do not spray water directly on sensors or electric connectors (sensors or electrical connection units, etc.). If water gets into the electrical system, it can cause operational problems.
- Use proper lighting devices when operating the machine in a dark area.
- Use lighting devices that are explosion-proof when handling flammable materials such as fuel and hydraulic oil.
- Never attempt to use a direct flame such as a cigarette lighter in lieu of the lighting device.
- Check the level of the cooling water after stopping and sufficiently cooling down the engine.
- Sufficiently relieve the inside pressure before opening the cooling water cap.
- The cooling system contains basic components. Use caution to prevent the skin or eyes from coming into contact with the basic materials.
- Exercise special care to protect the body from contact with hot fluid or parts.
- Replace the filters only after shutting off and sufficiently cooling down the engine.
- Slowly remove the operating oil filter plug to relieve the inside pressure.
- Relieve the pressure from the hydraulic system before disconnecting any lines and fittings.

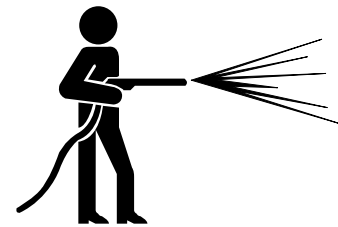

Collision or cutting

- Never perform a maintenance while the engine is running.
- Never open or remove the engine hood while the machine is in operation.
- If an inspection is required while the engine is running, two or more workers must perform the inspection.
- Keep areas in the vicinity of rotating or moving parts clean.
- Keep articles in the vicinity of the fan clean.
 - Wear safety gloves when handling the wire cables.
 - Wear protective goggles and protective clothes

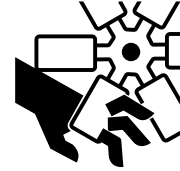
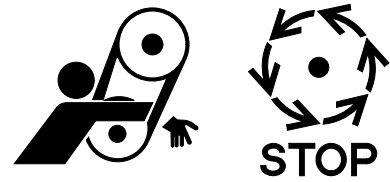

Preventing fire and explosion

- Use caution when handling fuels, lubrication oils, and coolant mixtures to prevent fire and explosion. Failure to comply may result in serious injury or death.
- Oil that leaks on to a hot surface or electronic components may cause a fire.
- Keep all fuels and lubrication oils in adequate containers.
- Do not smoke while refueling or while adding any fluids to the machine. Do not smoke near the fuel tank at anytime.
- Do not smoke in a space where battery electrolyte and other flammable materials are handled.
- Always keep all electrical lines, connectors, and clamps clean, and check whether they are securely connected on a regular basis.
- If any electrical wire or connector is loose or damaged, repair it immediately.
- Do not weld or cut with gas cutter pipes or tubes that contains flammable fluids.

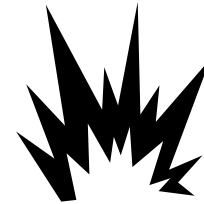

Cautions on decoupling the attachments

- Do not allow unauthorized workers to access the machine.
- Place the machine in a safe position.
- Install safety fences around the machine.

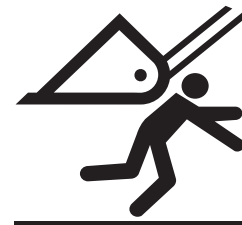

Repair by welding

- Only weld in an area where adequate facilities for welding are available.
- Welding work may be subject to risks of gas leak, flame and electric shock.

Welding should be performed only by a qualified welder.

- Take the following precautions when welding to avoid serious injury or death:
 - Separate and remove the battery to prevent battery explosion.
 - Perform direct heating in a place free from the risk of explosion.
 - Cover parts such as rubber hoses subject to damage by welding with flame-resistant materials.
 - Wear a welding helmet, protective clothes, protective gloves, and safety shoes.
 - Perform welding work in a well-ventilated place.
 - Remove all inflammable materials from areas in the vicinity of welding work.
 - Provide fire extinguishers.



Precautions to take when working on the machine

- There is a risk of falling when working on the machine.
- Keep the area around the workers' feet clean and tidy.
- Do not spill oil or grease.
- Do not leave tools lying on the floor.
- Be careful on the floor when moving.
- Never jump from the machine.
- When getting off the machine, use the step or handrail and get off the machine while keeping to the principle of three-point contact.
- Wear protective clothes if necessary.
- Do not perform maintenance work in an area where no anti-slipping pads have been installed.
- Replace anti-slipping pads and step treads with new ones if they have deteriorated or no longer function.

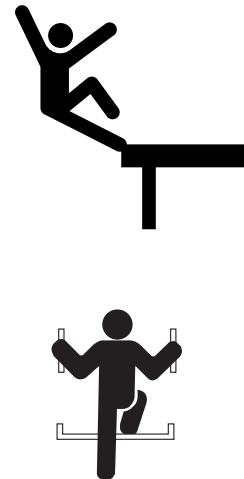

Cautions when working with the high-pressure line or hose

- Make sure that the internal pressure is released before replacing or checking the high-pressure line or hose.
- If the internal pressure is not released, serious injury may result.
- Take the following precautions to avoid serious injury or death:
 - Always check to make sure a working fire extinguisher is nearby
 - Leaked oil may penetrate the skin or cause serious injury.
 - Never check for oil leaks with your bare hands.
 - Check an oil leak using a wooden plate or cardboard.
 - Never bend or hit the high-pressure line hard.
 - Do not install a bent or damaged line or hose.
 - Make sure that all of the clamps and protective devices are properly installed.
- Check the pipes and hoses regularly and replace any damaged parts if necessary.

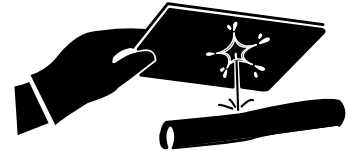

Cautions on inspecting the counterweight

- Failure to comply with these instructions may lead to serious injury or death.
- Never stand beneath the counterweight when installing or removing it.
- Make sure the condition of the lifting device is rated for the weight being lifted.
- Make sure lifting device is in good working order and free of damage or defects.



Battery

- The battery contains flammable materials.
- Never smoke in the vicinity of the battery.
- The battery electrolyte is strong acid. Pay attention to prevent the skin and eyes from coming into contact with the electrolyte.
- If the battery electrolyte accidentally comes into contact with the body or clothes, immediately wash off the electrolyte with water.
- If the battery electrolyte is frozen, do not use other devices to start the engine up.
- Always wear protective goggles and protective gloves when working on the battery.
- Always keep the switch in the 'OFF' position when working on the battery.
- Securely fasten the battery cap.
- Always disconnect the battery from the machine before charging the battery.
- Disconnect the cathode (-) first when removing the battery.
- Connect the anode (+) first when connecting the battery.
- Follow the safety procedures when jump starting or charging the battery. Improper connection of the cable may result in an explosion and serious injury.
- Use a voltmeter when inspecting the charging system.
- Regularly inspect the battery cable, and replace it if damaged.
- A battery cable with exposed wires may cause a short if it comes into contact with the grounding surface.
- A short circuit of the battery cable may cause heat from the battery current and result in a fire.
- If the wires of the ground cable are exposed between the battery and the master switch, the exposed wires make contact with the grounding surface and the current may bypass to the master switch. This may destabilize the machine operation.

Repair or replace the part before operating the machine.

Battery disconnection switch

- Do not turn off the battery disconnect switch while engine is running. There is a risk of damaging electrical system.
- The battery disconnect switch can be found under the left-hand door of the machine.
- Make sure to turn off the battery disconnect switch when welding or servicing electrical systems, and before clocking out.

Switchboard

- The relay and fuse can be found on the switchboard at the rear of the cab.
- Do not use the fuse that has a higher amperage than indicated on the decal. There is a risk of damaging electric circuits or catching fire.

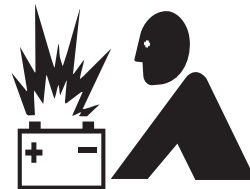

Parking and Storage

Cautions on parking

- Park the machine on flat ground.
- If parking the machine on a slope is unavoidable, use wheel chocks to prevent the machine from moving.
- Bring the bucket down and make firm contact with ground.
- Make sure that all of the switches are turned to the 'OFF' position.
- Do not turn off battery disconnect until led lamp at the disconnect goes off.
- Make sure that all of the controllers are turned to the neutral position.
- Stop the engine, and withdraw the ignition key.
- Close and lock the windshield, door and all covers.
- Install fences around the machine when parking it on a public road, and put up a warning sign.

Cautions on storage for a long period of time

- Park the machine in accordance to any state and local laws.
- When storing the machine for a month or longer, follow these instructions to prevent deterioration of the machine performance :
 - Thoroughly clean the machine before storing.
 - Inject sufficient lubrication oil and grease into the injection ports.
 - If any of the machines fluids are low top them off. If any fluids are close to or in need of changing, do so before storing.
 - Oils and coolant may deteriorate during storage based on the length of storage. Please take this into consideration before using the machine.
 - The density of the oil may drop during storage.
 - Apply an anti-rust additive to the exposed area of the piston rod of the cylinder in areas where it is likely to rust quickly.
 - Keep the master switch mounted in the power box (or the toolbox on the left of the rear frame of the machine) turned 'OFF'.
 - Keep the machine in a dry indoor environment.
If storing the machine outdoors is unavoidable, store it on a wooden pallet.
 - Keep all cylinders collapse so that the cylinder rods are not exposed.
 - Bring the attachments right down to the ground, and keep the tracks immobile by placing wheel chocks.



Regular lubrication (during storage)

- Breaking the lubrication film on parts may cause abnormal abrasion during the next operation.
- Check the level of the engine oil and coolant when starting the engine up, and top them up if necessary.
- Thoroughly wipe off any oil from cylinder rod before operating machine as it will attract dust and debris.
- Start up the engine once a month, perform all functions. Operate machine utilizing all functions for a minimum of 15 minutes. Apply lubrication oil to every part.
- Fully charge and store the battery.
- If storing the excavator for longer than 6 months, disconnect the battery negative (-) terminal.

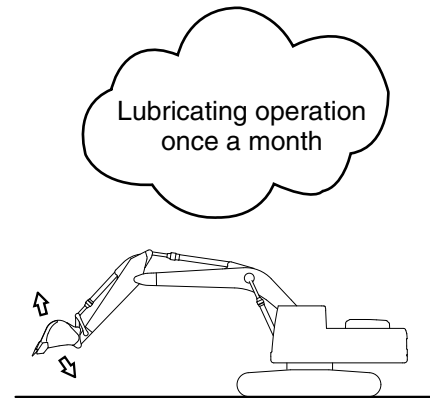

Visibility

Before you start the machine, perform a walk-around inspection in order to ensure that there are no hazards around the machine.

While the machine is in operation, constantly survey the area around the machine in order to identify potential hazards as hazards become visible around the machine.

Your machine may be equipped with visual aids. Some examples of visual aids are Closed Circuit Television(CCTV), AAVM(Advanced Around View Monitoring) and mirrors. Before operating the machine, ensure that the visual aids are in proper working condition and that the visual aids are clean.

If may not be possible to provide direct visibility on large machines to all areas around the machine, appropriate job site organization is required in order to minimize hazards that are caused by restricted visibility. Job site organization is a collection of rules and procedures that coordinates machines and people that work together in the same area.

Examples of job site organization include the following:

- Safety instructions
- Controlled patterns of machine movement and vehicle movement
- Workers that direct traffic to move when it is safe
- Restricted areas
- Operator training
- Warning symbols or warning signs on machines or on vehicles
- A system of communication
- Communication between workers and operators prior to approaching the machine

Modifications of the machine configuration by the user could result in a restriction of the machine visibility. In this case, a new risk assessment shall be performed according to ISO 5006:2017.

Restricted Visibility

The size and the configuration of this machine may result in areas that can not be seen when the operator is seated. The following illustration of visual map provides an approximate visual indication of areas of significant restricted visibility. This illustration indicates restricted visibility areas at ground level inside a radius of 12.00m (40 ft) from the operator on a machine only with the use of right side mirror and left side mirror installed. (without the use of optional visual aids.) This illustration provide areas of restricted visibility for distances outside a radius of 12.00m (40 ft).

This machine may be equipped with optional visual aids (CCTV or AAVM) that may provide visibility to some of the restricted visibility areas. For areas that are not covered by the optional visual aids, the job site organization must be utilized to minimize hazards of this restricted visibility.

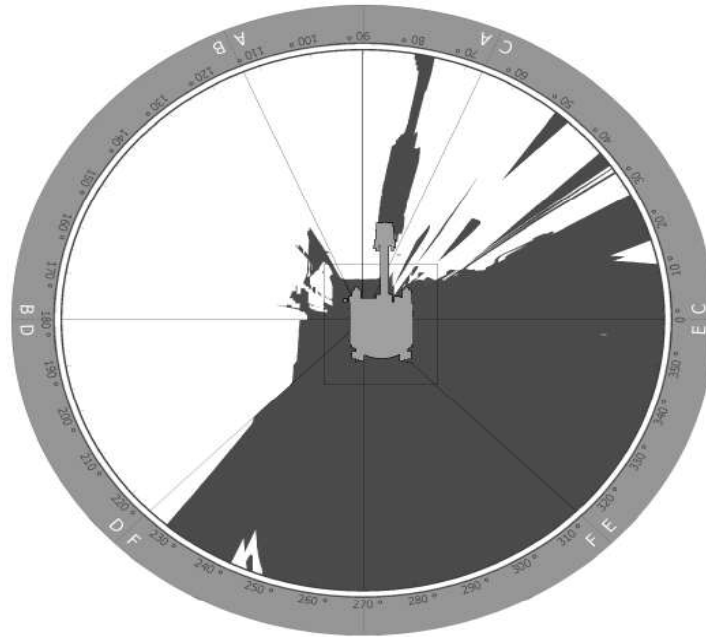

< Top view of the machine at ground level visibility without use of optional visual aids >

※ The shaded areas indicate the approximate location of areas with significant restricted visibility. (Radius = 12 m / 34 ft)

There is restricted visibility to the area directly behind the machine with no optional visual aids. Failure to make sure the area is clear could result in serious injury or death. Make sure that the area is clear with the other person on the ground before you start the reverse movement.

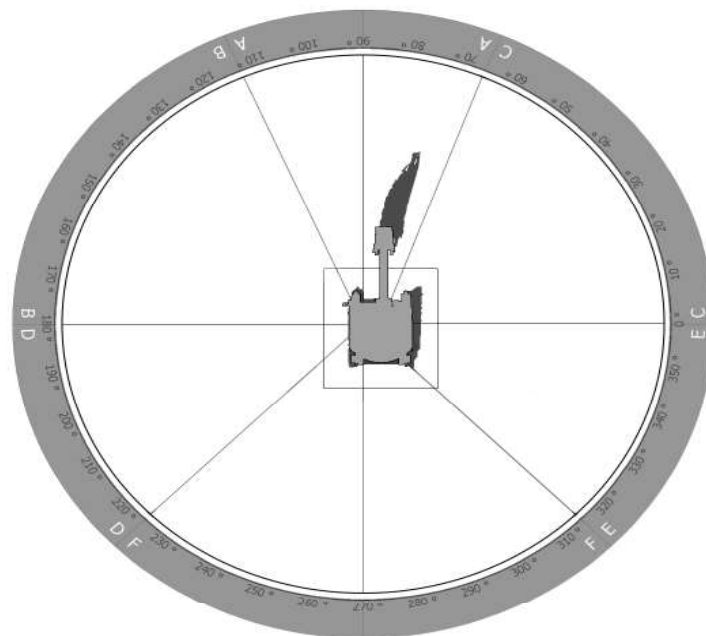

< Top view of the machine at ground level visibility with use of optional visual aids >

※ The shaded areas indicate the approximate location of areas with significant restricted visibility. (Radius = 12 m / 34 ft)